

SD CARD PIN DESIGN

PinNO.	Name	Description
1#	CD/DAT3	Card detect/data I/O
2#	CMD	Command
3#	VSS1	Ground
4#	VDD	Power
5#	CLK	Clock
6#	VSS2	Ground
7#	DAT0	Data I/O
8#	DAT1	Data I/O
9#	DAT2	Data I/O

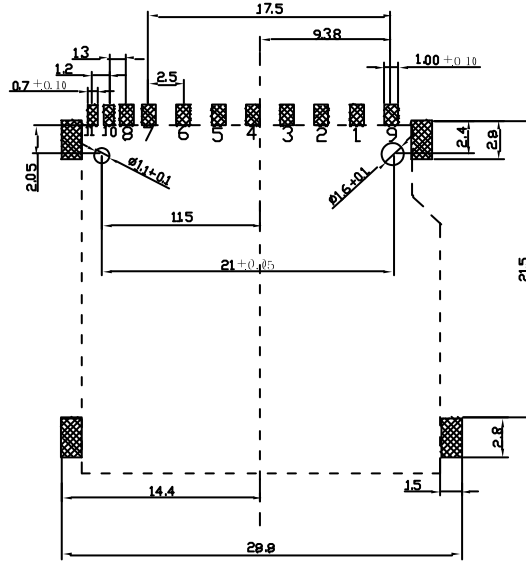

P. C. B Layout

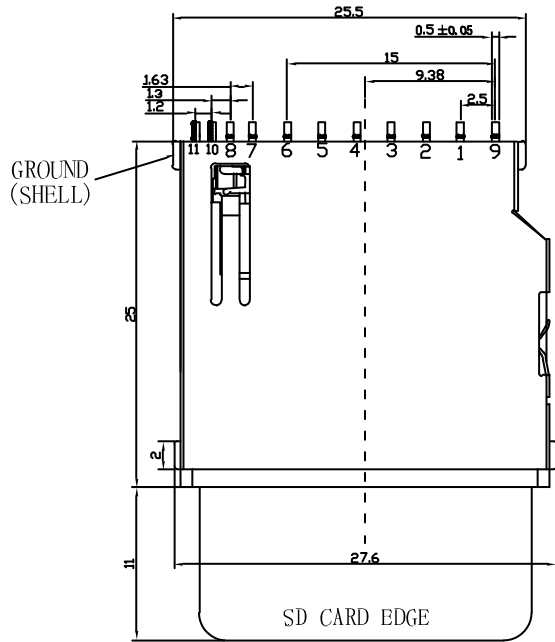
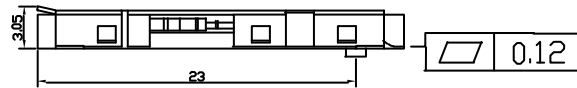
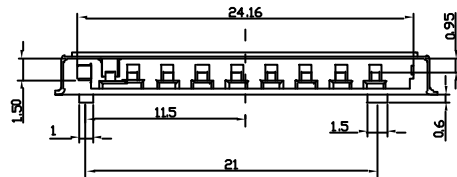

NOTES:

- MATERIAL**
HOUSING: HIGH TEMPERATURE THERMOPLASTIC.
CONTACT: COPPER ALLOY
SHELL: COPPER ALLOY
- PLATING**
CONTACT AREA: GOLD PLATED OVER NI
SOLDER TAIL: 100μ"MIN Sn PLATED OVER Ni
SPEC SEE ORDERING INFORMATION
SHELL SOLDER AREA: GOLD PLATED OVER Ni
- RATING**
CURRENT RATING: 0.5A
VOLTAGE RATING: 250VRMS
OPERATING TEMPERATURE: -25°C ~ 90°C
- SPECIFICATION**
CONTACT RESISTANCE: 40 Milliohms
DIELECTRIC WITHSTANDING VOLTAGE: 500VAC Megohms
INSULATION RESISTANCE: 100 Megohms
INSERTION FORCE: 40N MAX
SEPARATION FORCE: 2N MIN

10--WRITE PROTECT PIN
11--CARD DETECT PIN
GROUND(SHELL)--COMMON PIN

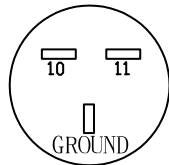

WITHOUT CARD

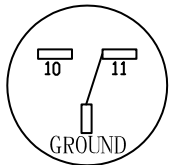

CARD INSERTED
WRITE PROTCT:LOCK

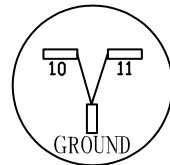

CARD INSERTED
WRITE PROTECT:UNLOCK

UNLESS OTHERWISE SPECIFIED TOLERANCE				台灣訊普電子科技有限公司
UNIT:	DECIMAL	LINEAR	ANGLES	
mm	X.	±0.50	±5°	
	X.X	±0.25	±3°	
	X.XX	±0.12	±1°	
www.xunpudianzi.com				
DRAWN	Fros	2014/12/12	DRAWN NAME:	
CHECKED	Ron	2014/12/12	Mini PCI Express Socket H: X.Xmm	
APPROVED	Albert	2014/12/12	PRODUCT NO.	SD-102
SCALE 3.2		SHEET 1/3	SIZE A4	

SPECIFICATION

Product Part Number SD-102

Product Description: Secure Digital Memory Card Connector Normal Type

1. SCOPE

1.1 Content

This specification covers performance, tests and quality requirements for Secure Digital Card Connector. These connectors are used to system signal transfer.

2. APPLICABLE DOCUMENTS

The following documents form a part of this specification to the extent specified herein. Unless otherwise specified, latest edition of the specification applies. In the event of conflict between requirements of this specification and product drawing, product drawing shall take precedence.

2.1. Commercial standards, specifications and report

2.1.1 MIL-STD -1344A

2.1.2 MIL-STD-202F

3. REQUIREMENTS

3.1 Design and Construction

Product shall be of design, construction and physical dimensions specified on applicable product drawing.

3.2 Materials and finish

- 3.2.1 Contact : High performance copper alloy (Phosphor Bronze)
Finish : (a) Contact Area: Gold plated based on order information
(b) Solder Tail area: tin-lead 90/10 100u" MIN.
(c) Underplate: 80u"min. Nickel-plated all over
- 3.2.2 Housing : LCP+30%GF, UL94V-0, Color: White.
- 3.2.3 Cover : Brass.
Finish : (a) Solder tail area: gold flash.
(b) Underplate: 80u"min. Nickel-plated all over

3.3. Ratings

- 3.3.1 Voltage : 200Volts DC, AC200 Volts(per pin)
- 3.3.2 Current: 0.5Amperes DC(per pin)
- 3.3.3 Operating Temperature : -20 to 90

3.4 Performance and Test Description

Product is designed to meet electrical, mechanical and environmental performance Requirements specified in Paragraph 3.5. All test are performed at ambient environmental condition per MIL-STD-1344 unless otherwise specified.

3.5. Test Requirements and Procedures Summary

Test Description	Requirement	Procedure
Examination of Product	Product shall meet requirements of Applicable product drawing and specification	Visual, dimensional and functional per Applicable quality inspection plan

ELECTRICAL

Low-Signal Level Contact Resistance	40m maximum initial R=20m maximum final	Mate subject connector with compatible Connector as shown in. MIL-STD-1344A, Method 3002.1
Insulation Resistance	1000M minmum initial R=100m maximum final	Apply DC 500 10% Volts between Adjacent contacts of mated Connectors for one minute. MIL-STD-1344A, Method3001.1, Test condition I
Dielectric Withstanding Voltage	500VAC initial and 250VAC final at sea level for1 minute. No discharge, flashover or Breakdown. Current leakage:0.5A max	Test between adjacent contacts of Mated/unmated connectors. MIL-STD-1344A, Method 3001.1, Test Condition I.

MECHANICAL

Retention Force	100Gram(0.98N) minimum (per pin)	Mate connector with a suitable gauge For each opin at rate of 25 mm/min. Measure force when gauge reaches Surface of connector. MIL-STD-1344A, Method2012.1
Insertion force	1000gGram(9.80N) maximum(for one product)	Mate connector with a suitable gauge For each pin at rate of 25 mm/min. Measure force when gauge reches Surfaces of connector. MIL-STD-1344A, Method2012.1
Separation Force	150Gram (1.47N) minimum(For one Product)	Mate connector with a suitable gauge For each pin at rate of 25 mm/min. Measure force when gauge reches Surfaces of connector. MIL-STD-1344A, Method2012.1
Durability	10000cycles. See Note(a)	The sample should be mounted in the Tester and fully mated and unmated The number of cycles apesified at the Rate of 25 mm/min. MIL-STD-1344A, Method2016

Vibration, random	No electrical discontinuity greater Than 1 μ second. See Note (a).	The electrical load condition shall be 100 mA maximum for all contacts. The specimen shall then be subjected To the vibration specified by the Test-condition letter for the duration as Specified 1.5 hours in each of three Mutually perpendicular directions. MIL-STD-1344A,Method 2005.1, Condition V, Test Condition letter A.
Physical Shock	No electrical discontinuity greater Than 1 μ second. See Note (a).	Subject mated connectors to 50 Gs (peak value)half-sine shock pulses of 11 milliseconds duration. Three Shocks in each direction shall be Applied along the three mutually Perpendicular axes of the test Specimen (18 shocks). The electrical Load condition shall be 100mA Maximum for all contacts. MIL-STD-1344A,Method 2004,1. Condoition A
Solderability	Solderable area shall have Minimum of 95% solder coverage.	Subject the test area of contacts into Flux for 5~10seconds and then into Solder bath, controlled at 260 \pm 5 for 3 0.5seconds.

ENVIRONMENTAL

Temperature Cycling (thermal shock)	See Note(a)	Subject mated connectors to 25 cycles Between -55 and 85 , 30 minutes Duration at both temperature Extremes. MIL-STD-1344A,Method 1003.1, ConditionA-1
Humidity-Temperature Cycling	See Note(a)	Subject mated connectors to 10 Humidity-temperature cycles between 25and 65 ,at 80-98%RH. MIL-STD-1344A,Method 1002.2, Type
Salt Spray	See Note(a)	Subject mated/unmated connectors to 5% salt-solution concentration,35 For 48 hours. MTL-STD-1344A,Method 1001.1, Condition B

Temperature life (Heat Aging)	See Note(a)	Subject mated connectors to Temperature life at 85 for 250 hours. MTL-STD-1344A,Method 1005.1, Test temperature condition 3, Test Time Condition B
----------------------------------	-------------	---

(a) Shall meet visual requirements, show no physical damage and shall meet requirements of Additional tests as specified in Test Sequence in Figure 1.

3.6 Product Qualification and Test Sequence

Test Group								
Test or Examination	1	2	3	4	5	6		
Test Sequence								
Examination of Product	1.7	1.6	1.3	1.10	1.5	1.9		
Low-Signal Level Contact Resistance	3.6	2.5		2.7	2.4	2.6		
Insulation Resistance				3.8		3.7		
Dielectric Withstanding Voltage				4.9		4.8		
Vibration		3						
Physical Shock		4						
Bounce Force	2.5							
Durability	4							
Solderability			2					
Temperature Cycling				5				
Humidity-Temperature Cycling				6				
Salt Spray					3			
Temperature Life(Heat Aging)						5		
Sample Size	8	8	4	8	8	8		